



Power distribution and automation product portfolio

Lucy Electric is a global leader in secondary power distribution solutions with over 100 years' industry experience.

Specialising in high-performance switchgear, we develop and supply intelligent solutions and services for utility, industrial and commercial applications.

This enables the safe and reliable distribution of energy to homes and businesses worldwide.

To find out more about us, visit:
www.lucyelectric.com

Contents

Applications	4	Low Voltage Distribution Cabinets	46
Medium Voltage Ring Main Units	6	AcuLok	48
Aegis 36	8	Multi Service Distribution Board, vertical	49
Aegis Plus	9	Multi Service Distribution Board, horizontal	50
Sabre	10	Sub Mains Distribution Board	51
Trident	11	Low Voltage Cut Outs	53
Scimitar	12	Heavy duty	55
Metering Units		Integrated CT	56
Aegis Plus	13	Pole mounted	57
Aegis 36	14	ABC distribution box	58
Sabre	15	Indoor house service	59
Oil	16	Outdoor house service	60
Medium Voltage Air Insulated Switchgear	17	Low Voltage Air Insulated Switchgear	61
SMART CLAD	18	SMART CDC	62
INECLAD	19	SMART CCM	63
SMART VAC	20	Energy Services	64
INEMOTOR	21		
Busbar Ducts	22		
High/Medium Voltage	24		
Rapier DSB	26		
Rapier GX	27		
Rapier SAX	28		
Isolating links	29		
Dropout fuses	30		
Distribution network monitoring, control and automation	32		
Gemini 3 platform	33		
Gemini 3 Modular RTU	36		
Gemini 3 Mini RTU	37		
Gemini SCADA solutions	38		
MCU 318	40		
MCU 520	41		
SlimSensor	42		
Data Centre	43		

Product panorama

Applications

Energy

- i) Generation: wind power, solar power
- ii) Distribution: compact substations, distribution networks

Infrastructure

- i) Tunnels, airports, ports, metro railway stations

Buildings

- i) Commercial buildings: hospitals, shopping centers, hotels, office buildings, data centers, warehouses, schools
- ii) Residential buildings: houses, apartments

Industries

- i) Water and waste water, mining, minerals, automotive, iron and steel, pulp & paper, cement and petroleum

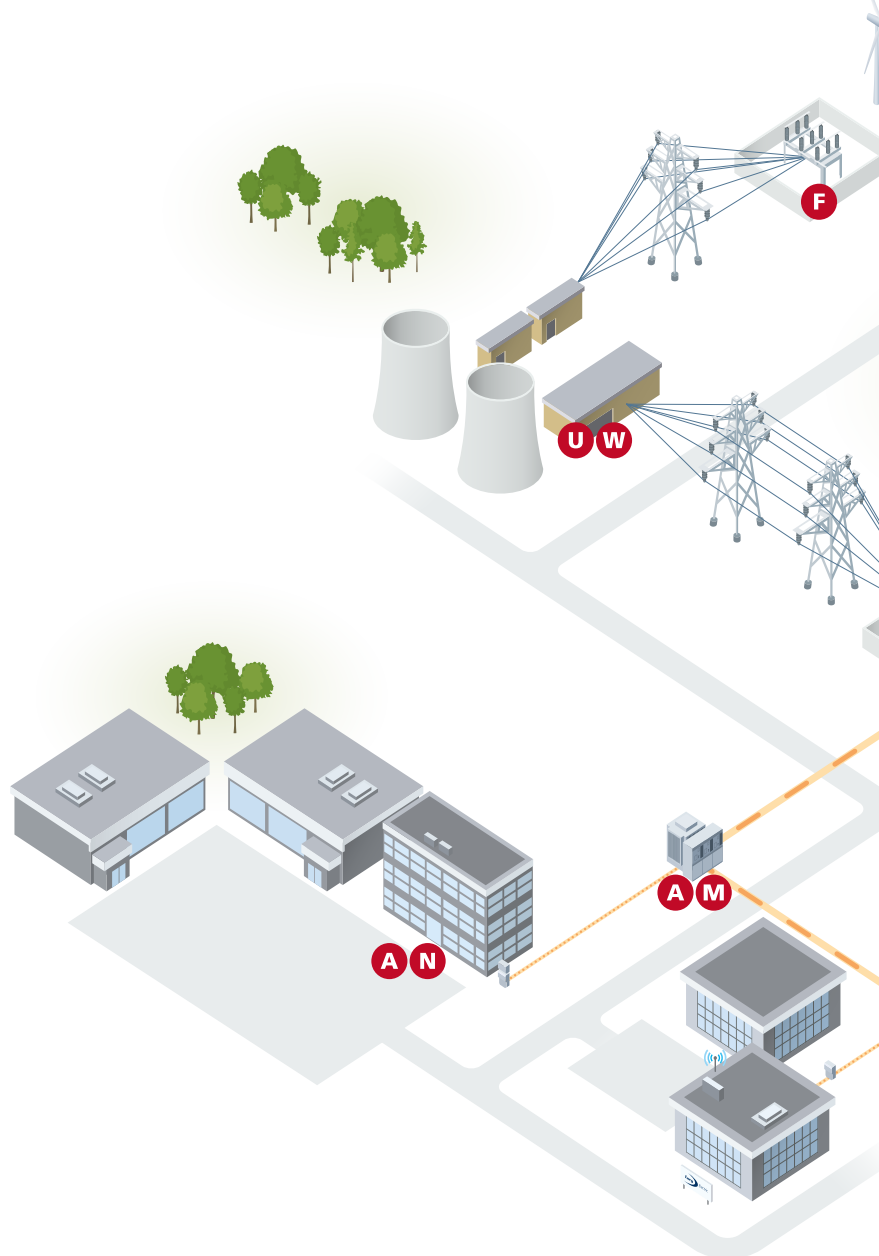

Ring main units

- A** Aegis Plus
- B** Aegis 36
- C** Sabre
- D** Trident

Switch disconnectors

- E** Rapier SAX
- F** Rapier DSB
- G** Rapier GX
- H** Isolating links
- I** Dropout (Expulsion) fuses

Automation

- J** Gemini 3
- K** Gridkey
- L** Data centre

Distribution cabinets

- M** AcuLok (BS fuses)
- N** MSDB

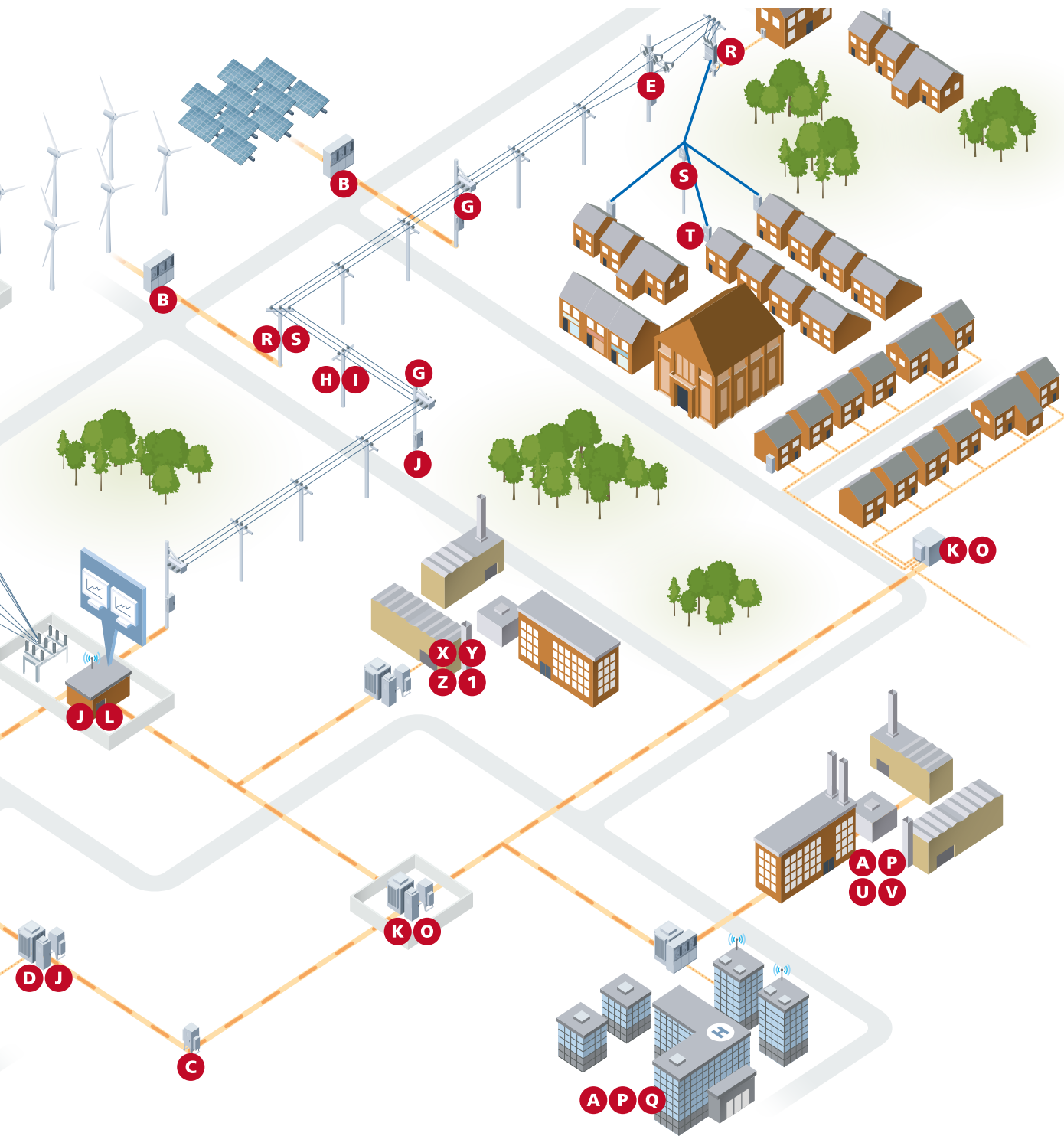

Distribution solutions

O Package substation

Cut outs

- P** Heavy duty cut outs
- Q** Integrated CT metering and heavy duty cut out
- R** Pole mounted cut out
- S** ABC distribution box
- T** House service cut outs

Medium voltage air insulated switchgear

- U** Smart Clad
- V** Smart VAC
- W** Ineclad
- X** Inemotor
- Y** Busbar ducts

Low voltage air insulated switchgear

- Z** Smart CDC
- 1** Smart CCM

Medium voltage

Ring main units

Lucy Electric is a market leader in the design and manufacture of high-performance medium voltage SF6 gas and oil insulated RMUs for transformer or ground mounted applications.

All RMUs are suitable for both indoor and outdoor locations and can operate in even the most extreme environmental conditions.

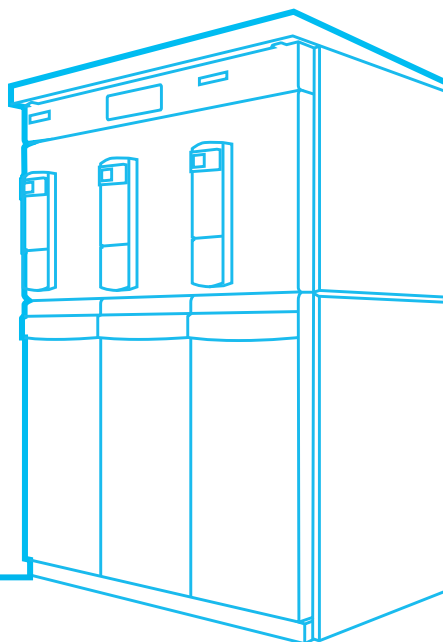

Range table - Ring main units and metering units

Ring main unit	Rated Voltage (up to)	Mode of fault current interruption	Insulation medium	Rated current (up to)	Mounting	Installation condition	Operation	Page
 Aegis 36	36 kV	Vacuum	SF6	630 A	Ground	Indoor/ outdoor	Local/ remote	8
 Aegis Plus	24 kV	Vacuum/ HV fuse	SF6	630 A	Ground/ transformer	Indoor/ outdoor	Local/ remote	9
 Sabre	24 kV	Vacuum	SF6	630 A	Ground/ transformer	Indoor/ outdoor	Local/ remote	10
 Trident	15.5 kV	Fuse	Oil	630 A	Ground/ transformer	Indoor/ outdoor	Local/ remote	11
 Scimitar	17.5 kV	Fuse	SF6	630 A	Ground/ transformer	Indoor/ outdoor	Local/ remote	12
Metering Units								
 Aegis Plus/ Aegis 36	24 kV/ 36 kV	-	Air	630 A	Ground	Indoor/ outdoor	-	13/14
 Sabre	15.5 kV	-	Air	630 A	Ground	Indoor/ outdoor	-	15
 Oil	15.5 kV	-	Air	630 A	Ground	Indoor/ outdoor	-	16

Aegis³⁶

SF6 insulated with vacuum circuit breaker protection

Front cable termination, SF6 insulated RMU with up to 4 switching functions in a single stainless steel enclosure



Characteristics

- 36 kV with up to 630 A ratings
- Extensible and non extensible range with a wide choice of configurations
- Any combination of load break switches and vacuum circuit breakers available
- No on-site SF6 gas handling for installation
- AF and AFLR internal arc protection
- Intuitive single line mimic diagram
- Horizontal cable terminations with DIN 400 Type C bushings
- Front access earth and test facility
- Integrated motorisation for remote control operation
- Vacuum circuit breaker protection with relays
- Suitable for Indoor (IP41) and outdoor (IP54) applications
- Integrated Gemini 3 RTU for easy SCADA connection, with optional automatic transfer scheme (ATS)
- Fully interlocked, anti-reflex mechanisms with padlocks
- Maintenance free with 30 years life expectancy

Technical Data

Rated voltage	kV	36
Rated current: ring switch	A	630
Rated current: vacuum circuit breaker	A	630
Impulse withstand voltage	kV	170/195
Power frequency withstand voltage	kV	200/220
Short time withstand current	kA 3s	50/62.5
Short circuit making current	kA	21 kA 3s/ 25 kA 1s
Short circuit breaking current	kA	
Internal arc rating	kA 1s	25

Range	Extensibility						
	Extensible				Non- extensible		
Configuration	1-way	2-way	3-way	4-way	2-way	3-way	4-way
Load break switch and/or 250 A circuit breaker	✓	✓	✓	✓	✓	✓	✓
Load break switch and/or 630 A circuit breaker	✓	✓	✓	✓	✓	✓	✓

Medium voltage - Ring main units

Aegis ^{Plus}

SF6 insulated with vacuum circuit breaker or fuse switch protection

Front cable termination, SF6 insulated RMU with up to 5 switching functions in a single stainless steel enclosure



Characteristics

- 12, 17.5 and 24 kV with up to 630 A ratings
- Extensible and non extensible range with a wide choice of configurations
- Any combination of load break switches, vacuum circuit breakers or fuse switch available
- No on-site SF6 gas handling for installation
- AF, AFL and AFLR internal arc protection
- Intuitive single line mimic diagram
- Horizontal cable terminations with DIN 400 Type C bushings
- Front access earth and test facility
- Integrated motorisation for remote control operation
- Vacuum circuit breaker protection with relays or TLF and fuse switch protection for transformers
- Suitable for Indoor (IP41) and outdoor (IP54) applications
- Integrated Gemini 3 RTU for easy SCADA connection, with optional automatic transfer scheme (ATS)
- Fully interlocked, anti-reflex mechanisms with padlocks
- Maintenance free with 30 years life expectancy

Technical Data

Parameter	Unit	12 kV	17.5 kV	24 kV
Rated voltage	kV	12	17.5	24
Rated current: ring switch	A	630	630	630
Rated current: vacuum circuit breaker	A	250 / 630	250 / 630	250 / 630
Fuse Switch	A	200	200	200
Impulse withstand voltage	kV	75 / 85	95 / 110	125 / 145
Power frequency withstand voltage	kV	28 / 32	38 / 45	50 / 60
Short time withstand current	kA 3s	21	21	21
Short circuit making current	kA	52.5	54.6	52.5
Short circuit breaking current	kA		21	
Internal arc rating	kA 1s		21	

Range	Extensibility							
	Extensible					Non- extensible		
Configuration	1-way	2-way	3-way	4-way	5-way	3-way	4-way	5-way
Load break switch and/or 250 A circuit breaker	✓	✓	✓	✓	✓	✓	✓	✓
Load break switch and/or 630 A circuit breaker	✓	✓	✓	✓	✓	✓	✓	✓

Sabre

SF6 insulated with vacuum circuit breaker protection

Lateral and rear cable termination, SF6 gas insulated RMU, fully weather proof with IP54 for outdoor applications.



Characteristics

- Up to 24 kV and 630 A ratings
- Non extensible, extensible and modular range
- Switching functions enclosed in SF6 gas insulated stainless steel tank sealed for life
- Intuitive single line mimic diagram for simple and safe operation
- Integrated cable earth and test facility
- Choice of TLF (time limit fuses) or self / auxiliary powered relay protection
- Anti reflex mechanism to prevent load break switch opening under fault conditions
- Fully interlocked operation with padlocking facility for maximum operator protection
- Freestanding and transformer mounted units
- Actuators (motorised) for ring switches and circuit breakers
- IP54 for outdoor installation without requiring a kiosk
- Seamless integration with SCADA network for remote operation and control
- Maintenance free with 30 years life expectancy

Technical Data

		12	15.5	17.5	24
Rated voltage	kV	12	15.5	17.5	24
Rated current: ring switch	A	630	630	630 / 400	630
Rated current: vacuum circuit breaker	A	250 / 630	250 / 630	400 / 630	250 / 630
Impulse withstand voltage	kV	75	95	95	125 / 145
Short circuit making current	kA	50	50	54.6	40
Short circuit breaking current	kA	20	20	21	16
Internal arc rating	kA / 1sec	20	20	21	16

Range	Description	Extensibility			
		Non extensible	Left hand extensible	Right hand extensible	Both ways extensible
Ring main units	2 ring switches and 250 A vacuum circuit breakers	✓	✓	✓	✓
Modular units	2 ring switches and 630 A vacuum circuit breakers	✓	✓	✓	✓
	250 A vacuum circuit breaker		✓	✓	✓
	630 A vacuum circuit breaker		✓	✓	✓
	630 A single ring switch		✓	✓	✓
	630 A double ring switch	✓	✓	✓	✓

Trident

Oil insulated with fuse protection

Lateral and rear cable termination, oil insulated ring main unit designed for harsh and corrosive environmental conditions.



Characteristics

- Up to 15.5 kV and 630 A ratings
- Non extensible, extensible and modular range
- Intuitive single line mimic diagram for simple and safe operation
- Integrated earth and test facility for easy and safe cable test without removing cable connections
- Anti reflex mechanism to prevent ring switch opening under fault conditions
- Fully interlocked operation with padlocking facility for maximum operator protection
- Freestanding and transformer mounted units
- Actuators (motorised) for ring switches
- Fuse switch fitted with shunt trips for remote tripping
- IP54 for outdoor installation without requiring a kiosk
- Seamless integration with SCADA network for remote operation and control
- Maintenance free with 30 years life expectancy

Technical Data

Rated voltage	kV	15.5 kV
Ring switch rated current:	A	630 A
Fuse switch rated current:	A	200 A
Mode of fault current interruption		HV fuses
Impulse withstand voltage	kVp	95 / 110 kVp
Short circuit making current	kA	50 kA
Short circuit breaking current	kA	20 kA

Range		Extensibility			
Product range	Description	Non extensible	Left hand extensible	Right hand extensible	Both ways extensible
Ring main units	2 ring switches and 200A fuse switch	✓	✓	✓	✓
Modular units	200 A fuse switch		✓	✓	✓
	630 A single ring switch		✓	✓	✓
	630 A double ring switch		✓	✓	✓

Scimitar

SF6 insulated with fuse protection

Lateral and rear cable termination, SF6 gas insulated ring main unit, fully weather proof with IP54 for outdoor applications.

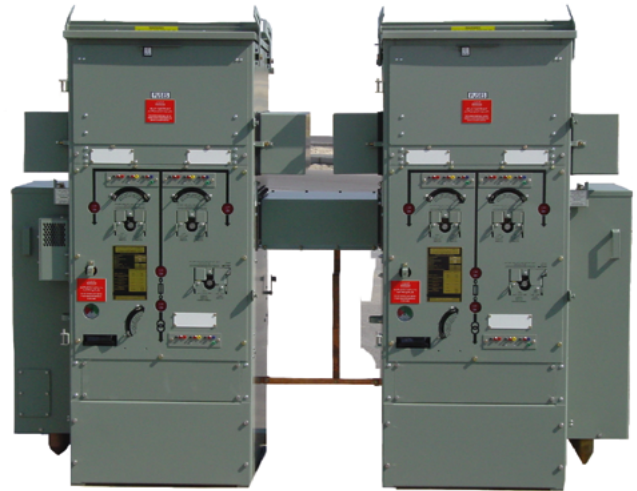

Characteristics

- Up to 17.5 kV and 630 A ratings
- Non extensible, extensible and modular range
- Intuitive single line mimic diagram for simple and safe operation
- Switching functions enclosed in SF6 gas insulated steel tank sealed for life
- Fully sealed, environment independent fuse compartment mounted outside SF6 filled tank (in air)
- Integrated earth and test facility for easy and safe cable test without removing cable connections
- Anti reflex mechanism to prevent ring switch opening under fault conditions
- Fully interlocked operation with padlocking facility for maximum operator protection
- Freestanding and transformer mounted units
- Actuators (motorised) for ring switches
- Fuse switch fitted with shunt trips for remote tripping
- IP54 for outdoor installation without requiring a kiosk
- Seamless integration with SCADA network for remote operation and control
- Maintenance free with 30 years life expectancy

Technical Data

Rated voltage	kV	12	15.5	17.5
Rated current: ring switch	A	630	630	400
Rated current: vacuum circuit breaker	A	200	200	200
Mode of fault current interruption		HV fuses		
Impulse withstand voltage	kVP	95	95	95
Short circuit making current	kA	62.5	62.5	54.6
Short circuit breaking current	kA	20	20	20
Internal arc rating	kA / 1sec	21	21	21

Range		Extensibility			
Product range	Description	Non extensible	Left hand extensible	Right hand extensible	Both ways extensible
Ring main unit	2 ring switches and 200 A fuse switch	✓	✓	✓	✓
Modular unit	200 A fuse switch		✓	✓	✓

Aegis ^{Plus} Air metering unit

Air insulated metering unit designed for Aegis Plus ring main unit range



Non-extensible AMU - Mt

Characteristics

- 12, 17.5 and 24kV ratings
- Rated current 630A
- HV fuse protection for VT (optional)
- Isolation switch for testing / fuse change
- Isolation switch for disconnection of non-fused variant (optional)
- Panel door locking facility
- Double cable termination (optional)
- Anti-condensation space heater (optional)
- Wide range of CTs and VTs supported
- IP41 for indoor and IP54 for outdoor applications

NB: IP54 is available in (non-extensible) freestanding range only

Air Metering Unit

Rated Voltage				
Frequency	Hz	50	50/60	50
Rated current	A	630	630	630
Impulse withstand voltage (between poles and earth)	kV	75	95	125
Power frequency with stand voltage (1 min - between poles and earth)	kV	28	38	50
Peak with stand current	kA	50	50	50
Short circuit making current	kA	50	50	50
Short time withstand current	kA 1s/3s	20/21	20/21	20
Internal Arc	kA 1s	20	21	20

Four metering functions are available:

Key • Available – Not available

Metering units	Non-extensible	Left Extensible	Right Extensible	Double Side Extensible	Indoor	Outdoor
M1 (Busbar In / Busbar Out)	–	–	–	✓	✓	–
M2 (Cable In / Busbar Out)	–	–	✓	–	✓	–
M3 (Busbar In / Cable Out)	–	✓	–	–	✓	–
Mt (Tarriff Metering)	✓	–	–	–	✓	✓

Aegis³⁶ Air metering unit

Air insulated metering unit designed for Aegis 36 ring main unit range



Non-extensible AMU - Mt

Characteristics

- 36kV ratings
- Rated current 630A
- HV fuse protection for VT (optional)
- Isolation switch for testing / fuse change
- Isolation switch for disconnection of non-fused variant (optional)
- Panel door locking facility
- Double cable termination (optional)
- Anti-condensation space heater (optional)
- Wide range of CTs and VTs supported
- IP41 for indoor and IP54 for outdoor applications

Air Metering Unit

Rated Voltage		
Frequency	Hz	50/60
Rated current	A	630
Impulse withstand voltage (between poles and earth)	kV	170/190
Power frequency with stand voltage (1 min - between poles and earth)	kV	70
Peak with stand current	kA	62.5/65
Short circuit making current	kA	62.5/65
Short time withstand current	kA 1s/3s	20/35
Bus bar size cross section	mm ²	25/15
Internal arc	kA 1s	25

Four metering functions are available:

Key • Available – Not available

Metering units	Non-extensible	Left Extensible	Right Extensible	Double Side Extensible	Indoor	Outdoor
M1 (Busbar In / Busbar Out)	–	–	–	✓	✓	–
M2 (Cable In / Busbar Out)	–	–	✓	–	✓	–
M3 (Busbar In / Cable Out)	–	✓	–	–	✓	–
Mt (Tarriff Metering)	✓	–	–	–	✓	✓

Sabre

Air metering unit

Air insulated metering unit designed for Sabre ring main unit range



Characteristics

- Up to 17.5 kV and 630 A ratings
- Freestanding and RMU mounted version
- Voltage transformer (VT) isolation for HV testing
- Bus bar metering and tee off metering options
- Trip lock out relay for RMU / AMU combinations for emergency tripping
- Wide range of CT and VT to suit various application needs
- IP54 for outdoor installation without requiring a kiosk

Technical Data			
Rated voltage	kV	12	15.5
Rated current	A	250 / 630	250 / 630
Short time withstand current	kA / 3sec	20	20
Bushings		Din 400 type C	
Impulse withstand voltage	kVP	75	95
Short circuit making current	kA	50	50
Cable connection		3 single core cables / single 3 core cable	

Range		Connection	
Product range	Description	RMU tee off metering	Bus bars metering
Air metering unit	250 / 400 / 630 A air insulated metering unit	✓	✓

Trident Oil metering unit

Oil insulated metering unit designed for Trident ring main unit range



Characteristics





- Up to 15.5 kV and 630 A ratings
- Freestanding and RMU mounted version
- Voltage transformer (VT) isolation for HV testing
- Bus bar metering and tee off metering options
- Trip lock out relay for RMU / AMU combinations for emergency tripping
- Wide range of CT and VT to suit various application needs
- IP54 for outdoor installation without requiring a kiosk

Technical Data

Rated voltage	kV	12 / 15.5
Rated current	A	250 / 400 / 630
Short time withstand current	kA/3 sec	20
Bushings		Din 400 type C
Impulse withstand voltage	kVp	75 / 95
Short circuit making current	kA	50
Cable connection		3 single core cables / single 3 core cable

Range		Connection	
Product range	Description	RMU tee off metering	Bus bars metering
Oil metering unit	250 / 400 / 630 A air insulated metering unit	✓	✓

Range table - Medium voltage air insulated switchgear

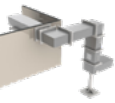
Air Insulated switchgear	Rated Voltage	Mode of fault current	Insulation medium	Rated current	Mounting	Installation condition	Operation	Cable access	Page
 SMART CLAD	38 kV	Vaccum	Air	2500	Ground	Indoor/ outdoor	Local/ remote	Rear	18
 INECLAD	24 kV	Vaccum	Air	2500	Ground	Indoor/ outdoor	Local/ remote	Rear	19
 SMART VAC	38 kV	Vaccum	Air	3150	Ground	Indoor/ outdoor	Local/ remote	Top	20
 INEMOTOR	7.2 kV	Vaccum	Air	2500	Ground	Indoor	Local/ remote	Rear	21
 Busbar ducts	13.8 kV	-	Air	-	-	-	-	-	22

SMART CLAD

Air-insulated MV switchgear

SMART CLAD panels are designed for the operation and protection of electric distribution circuits up to 36 kV, having as main equipment a vacuum circuit breaker mounted on a removable cart.

Different functions are available, incorporated in a multi-cubicle modular construction. SMART CLAD panels are used in a variety of applications: from electricity distribution companies to petrochemical, mining, steel, chemical, cement and other industries.



Characteristics

- Rated voltage up to 36 kV
- Suitable for use in indoor and outdoor applications
- Operator and public safety guarantee due to its high
- Internal arc rating
- Extensibility for both sides of the panel
- A large number of possible configurations due to the functions available
- Extensive range of extra equipment: protection relays, VTs, CTs, surge arresters, etc.
- Virtually nonexistent maintenance
- Earthing switch for short-circuit opening
- Interlocks ensure safe and reliable operations

Technical Data

Rated voltage	kV	17.5	36/38
Rated power frequency withstand voltage	kV	38/45	70/80
Rated lightning impulse withstand voltage	kVp	95/110	170/195
Short circuit breaking capacity	kA	25/31.5/40	25
Rated short time withstand current	kA 3s	25/31.5/40	25
Rated peak withstand current	kAp	65/82/105	65
In the busbar compartment, with natural ventilation	A	Up to 2500	Up to 2000
Circuit breaker function, with natural ventilation	A	Up to 2500	Up to 2000
Sectionalizer	A	630	

Internal Arc (IAC)

Internal arc classification		BF-ALR	BFLR
Breaking capacity	kA/0.5 s	40	25

Available functions

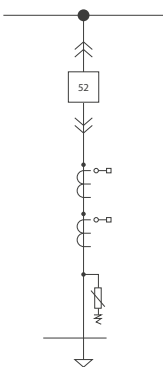

Feeder functions

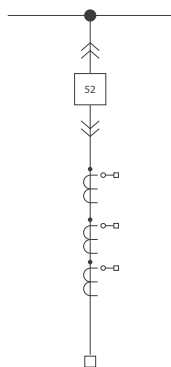

Switching functions

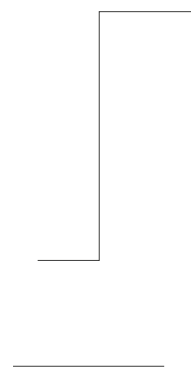

Transition with measurement function

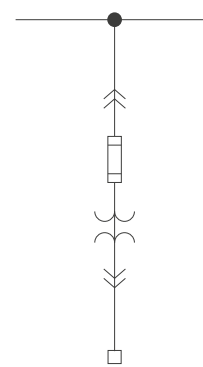

Disconnecter function

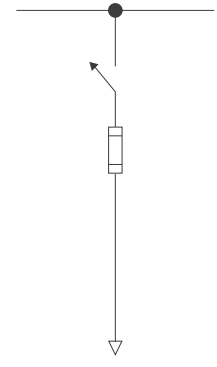

Bus coupler function

INECLAD

Air-insulated MV switchgear

INECLAD has been designed for the operation and protection of electric distribution circuits up to 24 kV, having as main equipment a vacuum circuit breaker mounted on a removable cart. Its components are housed in compartments separated by metal partitions (through multi-cubicle type modular construction), according to national and international standards.

INECLAD panels are used in a variety of applications: from electricity distribution companies to petrochemical, mining, steel, chemical, cement and other industries.



Characteristics

- Internal arc resistance (according to the five criteria of the IEC 62271-200 / 2003 standard): 31.5 kA for 1s - all compartments
- Interlocking that prevent wrong operation sequences
- Earth switch lockout
- Interlocking with the low voltage plug, preventing the door from being closed if the plug is disconnected
- Segregated busbar compartment, such that in case of an internal arc event, it affects that compartment only, avoiding the loss of other functional units, according to ANSI requirements.
- Insertion and removal of manoeuvring equipment with the door closed, increasing the safety of operation
- Internal access only when the breaker is in test or withdrawn position
- High mechanical rigidity
- Busbar arrangement ensures resistance to high short circuit currents
- Extensibility on both sides of the panel
- Easy access to internal components

Technical Data				
Rated voltage	kV	7.2	15	24 ¹
Frequency	Hx	50/60		
Rated current	A	630 to 3150		
Rated lightning impulse withstand voltage	kV	60	95/100 ¹	125 ¹
Rated power frequency withstand voltage	kV	20	34	60 ¹
Rated short time withstand current		12.5 to 50 ²		
Ingress protection		IP42/IP55 ³		

Available functions

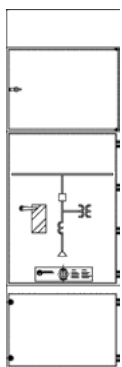

In/out

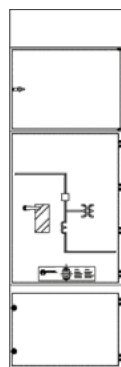

Circuit breaker with busbar connection



Busbar connection

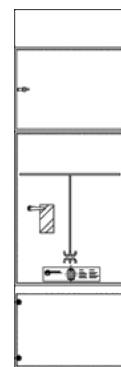

Metering

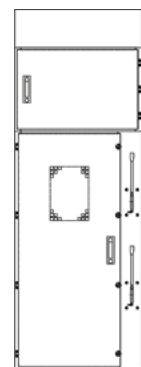

Sectionaliser

SMART VAC

Medium Voltage circuit breaker

The use of SMART VAC circuit breakers optimises the availability of power supply in distribution networks, allowing the operation of different load profiles.

SMART VAC features reclosing, electrical measurement, monitoring, control, and special loads operation (e.g. capacitor banks, reactor banks).



Characteristics

- Rated voltage up to 36 kV
- Designed for outdoor use
- High degree of safety with internal arc test
- A large number of possible configurations.
- Great flexibility for protection relays, VTs, CTs, surge arresters, etc.
- Low maintenance required by using vacuum circuit breakers
- Interlocks ensure safe and reliable operation
- Type tested to IEC 62271-200
- Internal arc protection (optional)

Technical Data				
Rated voltage	kV	15	24	36
Rated current	A	Up to 3150	Up to 3150	Up to 2500*
Rated frequency	Hz	50/60		
Rated lightning impulse withstand voltage	kV	95/110	125	170
Rated power frequency withstand voltage	kV	38	50	70
Short circuit breaking capacity	kA	40	40	25*
Circuit breaker mechanism operation sequence		O-0.3 s - CO - 15 s - CO		
Mechanical endurance		≥ 10.000 operations		

INEMOTOR

Control centre for MV motors

INEMOTOR panels are designed as medium voltage motors control centres. Using air insulated metal enclosures with vacuum contactors, designed to be equipped in substations INEMOTOR panels are designed as medium voltage motors control centres. Using air insulated metal enclosures with vacuum contactors, designed to be equipped in substations.

The motor control centres are widely used in several industrial segments: substations, industrial installations for motor protection, switching, and starting, pumping stations.

INEMOTOR panels provide a high reliability standard.



Characteristics

- Internal arc resistance, type tested in an independent laboratory as per IEC standards, ensuring the safety of operation.
- Interlocking between the door of the circuit breaker compartment and the circuit breaker extraction cart.
- Separate low voltage compartment, allowing an easy assembly of metering and protection equipment.
- Reduced dimensions

Technical Data		
Rated voltage	kV	7.2
Frequency	Hz	50/60
Main busbar current	A	1250/2500
Short circuit breaking capacity	kA, 1 s	25/31.5
Rated lightning impulse withstand voltage	kV	60
Rated power frequency withstand voltage (60 Hz)	kV	20
Ingress protection class		IP42
Internal arc classification		AFLR
Internal arc breaking capacity	kA, 1 s	25
Loss of continuity of service		LSC2B

Busbar ducts

Busbar ducts are structures intended for electrical distribution, usually carrying high electric currents from the plant transformer to the point of consumption, this being a distribution panel or even being connected directly to a load.

Electrical distribution becomes safe and practical with the use of busbar ducts, since they provide the necessary operational reliability in the installations to which they are incorporated.

Bus ducts are widely used in a range of applications, from large industries to power generation systems.

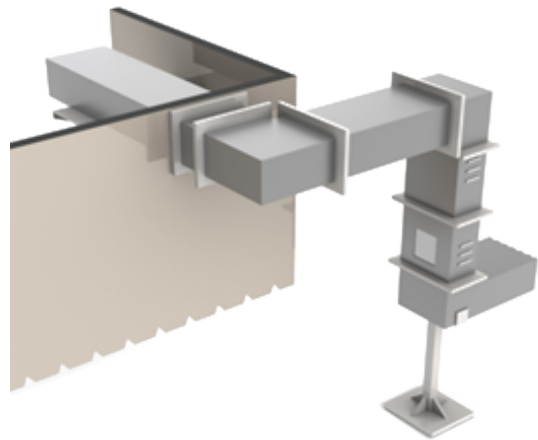

Technical Data		
Electrical characteristics	LV	MV
Voltage rating (kV)	0.6	7.2 and 13.8
Normal voltage (kV)	0.48	7.2 and 13.8
Rated lightning impulse withstand voltage (kV)	-	95
Nominal current (A)	up to 5000	up to 3150
Short circuit current - I _{cc} (kA)	50	31.5
Peak withstand current (kA)	105	125
Mechanical characteristics	LV	MV
Enclosure		
Medium voltage		2500 A 3150 A
Low voltage		2500 A 3000, 4000 and 5000 A
Connections		
Medium voltage		Silver plated
Low voltage		Silver plated
Ingress protection		
For indoor and outdoor use - MV and LV		IP55
Optional equipment		Fire barrier wall



High / Medium voltage



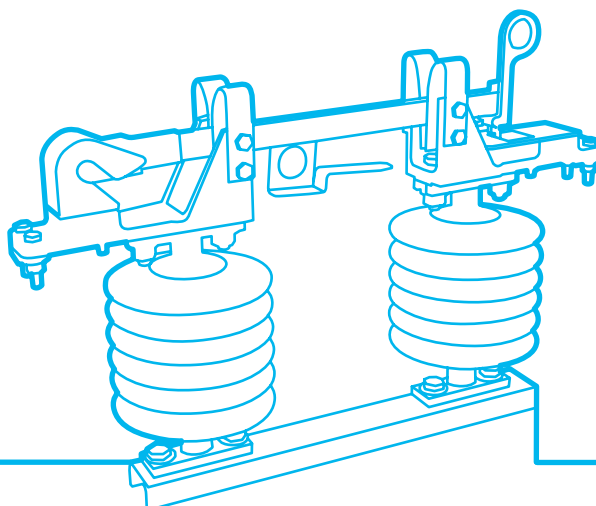

Switch disconnectors

Lucy Electric's range of high and medium voltage switch disconnectors include pole or structure mounted air break disconnectors and air and gas load break switches.

These switch disconnectors provide best-in-class solutions and are designed to anticipate the evolving technical and market demands of our customers.



Range table - Switch disconnectors

Switch disconnectors	Rated Voltage	Mode or fault current interruption	Insulation medium	Rated current up to	Mounting	Installation condition	Operation	Page
 Rapier DSB	36 kV	-	Air	1250 A	Pole	Outdoor	Local/remote	26
 Rapier GX	145 kV	-	Air	2500 A	Structure	Outdoor	Local/remote	27
 Rapier SAX	38 kV	-	SF6	630 A	Pole	Outdoor	Local/remote	28
 Isolating links	36 kV	-	Air	400 A	Pole	Outdoor	Local	29
 Dropout fuses	36 kV	Fuse	Air	100 A	Pole	Outdoor	Local	30

Rapier DSB

Double side break switch disconnector

The Rapier double side break disconnector range provides a powerful and cost effective solution for isolating circuits and equipment in substation applications. Based on open terminal air break technology, the range combines robustness and alignment reliability.

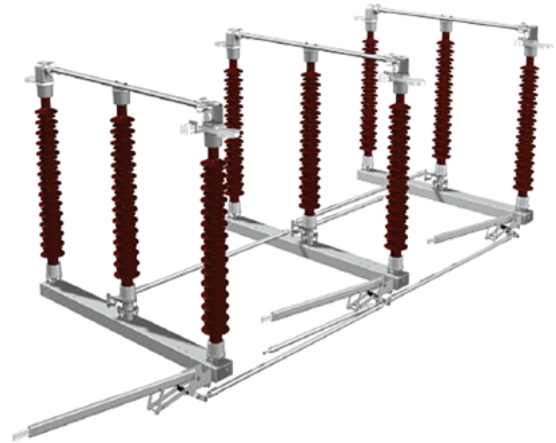

Characteristics

- Ratings up to 145 kV and 2500 A
- Robust design
- High endurance and reliability
- Suitable for horizontal and vertical installation
- Fault withstand current up to 40 kA / 3sec
- Double side break
- Optional integral earth blades either or both sides
- Manual or motor operation

Accessories

Busbar connectors:

- Up to 145 kV
- Fixed and expansion type
- Available in copper and aluminium

Technical Data				
Rated voltage	kV	36	72	145
Rated current	A	2000	2500	2500
STC withstand	kA / 3 sec	31.5	40	40
Peak withstand current	up to kA	78.75	100	100
Earth blades	kA	31.5	40	40
Bus transfer current	kA	1600	1600	1600
Load break current	A	800	n/a	n/a
Key interlocks		6	6	6



Rapier GX

SF6 enclosed load break switch and sectionaliser

The Rapier GX pole-mounted, gas insulated, load break switch has been developed as a complementary alternative to Rapier AX air break switches.

Available up to 38 kV, the GX switch has been designed using SF6 puffer switching technology, delivering high performance and reliability. Whether operated as a simple, manually-independent switch or equipped with fully automated features, the GX switch is suitable for all sectionalising and network automation requirements.



Characteristics

- Stainless steel tank sealed for life
- Hookstick or motor operated
- Suitable for single wood pole mounting (other arrangements available)
- Independent spring operation ensuring consistent opening and closing times

Technical details

- Available in different versions
- Current rating of 630 A
- Optional internal voltage transformer for 15 kV version
- Internal arc withstand

Technical Data				
Rated voltage	kV	17.5	24 kV	38 kV
Frequency	Hz	50/60	50/60*	50/60
Rated normal current	A	630	630	630
Lightning impulse withstand voltage (peak)	kV	95/110	125/150	150/195
Power frequency withstand voltage (rms)	kV	38/45	50/60	70/80
Current ratings				
Rated short time withstand current		16 kA, 1 sec	16 kA, 1 sec	16 kA, 1 sec
Rated peak withstand current	kA	41.6	31.3/40	32.5
Internal arc protection		Type C - 16 kA, 1 sec		
Operation performance				
Operating temperature	°C	-25 to +55	-25 to +50	-25 to +55
Altitude		Up to 1000 m (without de-rating)		
Mechanical endurance class	class	M2	M2	M2
Number of mechanical operations	ops.	5000	5000	5000
Number of load-break operations	ops.	100	100	400
Electrical endurance class	class	E3	E3	E3
Number of short-circuit making operations	ops.	5	5	5
Capacitive current class	class	C2	C2	C1
General information				
Insulator type		Polymetric bushings		
Bushing creepage distance	mm	525	768	1082
Gas enclosure ingress protection	Class	IP65		

24 kV unit tested at 50 Hz, but valid for both 50 and 60 Hz, as per IEC 62271

Rapier AX Solid Blade

Air break switch disconnector Up to 36kV

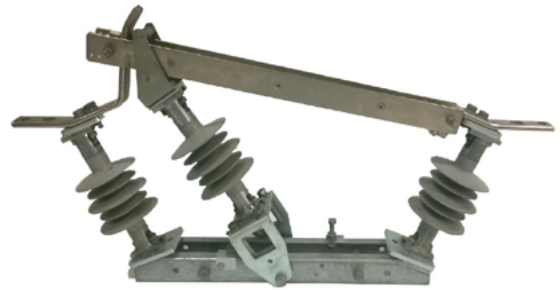

The Rapier AX Solid Blade air break switch disconnector is an evolution of the existing Rapier RX and AX air break switch disconnector.

The tin plated multiple copper laminate strips have been replaced with 2 plated copper bars which form the main current path and also the moving female contact, this complete air break switch disconnector normally comprises of 3 single phase units ganged together with a common operating mechanism ensuring that all phases open and close at the same time.

The mounting base is common across all three voltage ranges – 12/15.5, 24 and 36 kV making design of mounting steelwork simpler.

Characteristics

- Designed and manufactured to meet or exceed the requirements of IEC 62271
- Accommodates many customer specific requirements where they differ from IEC
- Silicone insulators with minimum of 25mm/kV creepage
- Plated HDHC copperwork for longevity of life
- Available in 12/15.5 kV, 24 kV and 36 kV voltage ranges
- Standard current ratings of up to 1250 A
- Short time withstand current of 25 kA rms for 3 seconds with 62.5 kA peak
- Standard fault make capacity of 3 kA rms with 7.5 kA peak
- Compact and robust construction
- Suitable for horizontal and vertical mounting
- Suitable for mounting pole top (above the line) or underslung (below the line)

Technical Data				
Rated voltage	kV	12/15.5	24 kV	36 kV
Frequency	Hz	50/60*	50/60*	50/60*
Rated normal current	A	630/800	630/800	630/1250
Power frequency withstand voltage (rms)				
Common dry	kV	50	70	95
Common wet	kV	45	60	80
Isolating dry	kV	55	77	105
Distance wet	kV	50	66	88
Lightning Impulse Withstand Voltage (peak)				
Common	kV	110	150	200
Isolating distance	kV	125	165	220
Rated short time withstand current	kA	25	25	25
Rated duration of short circuit	sec	3	3	3
Rated peak withstand current	kA	62.5	62.5	62.5
Rated peak making current	kA	3	3	3
Rated peak making current	kA	7.5	7.5	7.5
Optional - rated making current	kA	13.1 10	10	10
Optional - rated peak making current	kA	25	25	25
Breaking Current				
Mainly active load	A	20	10	10
Closed loop	A	300	300	300
Mainly active load (optional)	A	630	630	630
Closed loop (optional)	A	630	630	630
Insulator type	Silicone rubber with alternated sheds			
Creepage distance	25mm/kV minimum			
Mechanical endurance class	M1 (2,000 operations)			
Electrical endurance class (load break)	E1 (10 operations)			
Electrical endurance class (earth switch)	E1 (2 operations)			

Isolating links

The Lucy Electric range of HV isolating links provide a reliable and economic solution for the isolation of overhead distribution lines and transformers and a visual indication of operation and positive disconnection from supply. Available in 12 kV and 36 kV options, each single phase link unit can be attended from the ground with an insulated operating pole.



Characteristics

- Removable link for safe point of isolation
- Spring-loaded, latched operation
- Hookstick operation
- Porcelain or polymeric insulator options

Technical details

- Voltage range: 12 and 36 kV
- Current rating: 400 A
- Short time current: 16 kA / 3sec at 12 kV; 12.5 kA / 3 sec at 36 kV
- Integral connector terminals suitable for conductor sizes up to 19 mm diameter

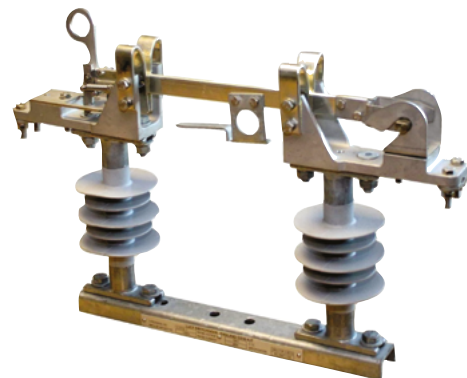

Technical Data			
Rated voltage	kV	12	36
Rated current	A	400	400
STC withstand	kA / 3 sec	16	12.5
Peak withstand current	kA	40	31.25

Dropout (expulsion) fuses

The Lucy Electric range of dropout (expulsion) fuses provides a reliable and economic method of protecting circuits and equipment. When used in its trip all phase version, it ensures safe disconnection of supply when a fault occurs on just one phase.

Characteristics

- Fuse assembly with rewireable fuselink
- Hookstick operation
- Visual indication from ground level of blown fuse
- Porcelain or polymeric insulators

Technical Details

- Button type fuselink up to 100 A
- Available in 12, 24 and 36 kV versions
- Spring loaded flipper ensures constant contact pressure
- Optional trip all phase (TAP) three phase unit





Distribution network monitoring, control and automation

Lucy Electric's complete range of automated power distribution products gives customers a choice of automation building blocks which can be tailored to offer a complete smart grid solution.

At the cutting edge of medium voltage switchgear design for both ground and pole-mounted switchgear, the products offer a genuinely systems-engineered approach to smart grid solutions.

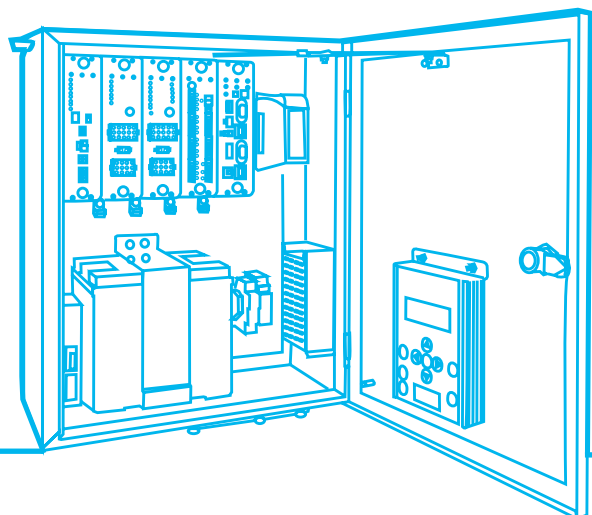

Gemini 3 platform

Gemini 3 is a flexible platform for advanced feeder automation on electrical distribution networks. This platform comprises two ranges with the same common look and feel, communication and configuration environment. Whilst the two ranges are differentiated by their flexibility and switchgear utilisation, the Gemini 3 platform provides the user with a consistent approach and interface experience.

Features

Common HMI and user experience

The HMI allows local controls to be issued by an authorised Engineer (security enabled) or just provide data to be viewed locally. The configuration and commissioning environment is common to both ranges.

Communication protocols

- IEC 60870-5-101 and IEC 60870-5-104
- DNP 3.0
- Modbus

Alarms and events

7000 events (1ms resolution) are stored in non-volatile memory. Alarms and event logs are available locally (via the optional HMI) or remotely via the SCADA communications. Alarms and event logs are also available via the configuration and commissioning software. Gemini 3 has a real-time clock with synchronisation available via NTP, GPS and SCADA protocol.

Security compliance

The Gemini 3 Family has been designed to be a secure element of a distribution automation system and has undergone extensive security testing, both in house and with external organisations. The Gemini 3 RTU uses a number of techniques to eliminate security vulnerabilities including:

- Stateful packet inspection firewall
- Service and port restriction
- Multi-layered access controls
- Role based authentication and authorisation

We are constantly reviewing product security and keep a close watch on new threats and attack vectors. As appropriate Lucy Electric will respond to identified risks and enhance the security of our products.

Advanced analogue measurement

Analogue measurement options are available across the range, providing additional measurements and fault detection.

Fault passage indication and detection

- Fault indication (3 phase and earth)
- Directional fault indication (3 phase and earth)
- Sensitive earth fault detection (SEF)

Automation schemes

Standard pre-tested schemes available include automatic sectionalising and automatic change-over functions, using the IEC 61499 programming language. Additional customised schemes available including self-healing network applications.

Automation benefits of Gemini 3

The Gemini 3 continues Lucy Electric's next generation of highly successful Gemini remote terminal units, forming a key part of our cutting-edge range of automation solutions. Gemini 3 offers a comprehensive solution for measurement, fault location, automation and remote monitoring and control of power distribution networks.

Gemini 3 helps utilities to manage their networks better, providing efficient and effective solutions to improve network reliability and operational costs. Remote control of the networks can be achieved incrementally, improving the quality of service through accurate fault detection, outage management and restoration maximising feeder utilisation and gaining return on investment whilst preserving the customer's satisfaction.

The additional benefit of investing in Gemini 3 is the enhanced understanding of the state of the distribution network. This supports a predictive maintenance approach and the flexibility of Gemini 3 will help extend the life of existing assets and provide increased functionality.

With the growth in renewables and other forms of low carbon technologies, Gemini 3 is smart grid ready providing additional network management functions including:

- cable pressure monitoring
- fault detection, isolation and restoration
- automated load transfer
- timed connections
- import / export limit management
- interfacing to active network management systems

Together with the ability to measure MV & LV power quality, Gemini 3 will improve the customer perception of the utility being an energy supplier.

Improved network reliability

- Reduced customer minutes lost (improving SAIDI)
- Reduced customer interruptions (improving SAIFI)

Improved network efficiency and utilisation

- Faster response to faults, no travel required for initial switching
- Better fault location, operators are sent to a pre-sectioned circuit
- Less time spent on routine switching
- Improved operations as rural network expands
- Load transfers for deferring reinforcement for overloaded primary

Improved safety

- Increased safety as operators can stand away from the equipment
- No need to enter sites with poor access for routine switching

Gemini 3 Modular RTU

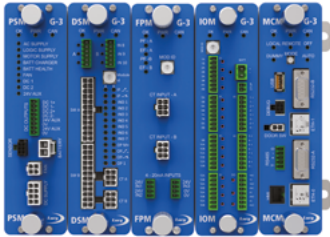

The established Gemini 3 Modular RTU incorporates advanced features and flexibility allowing customers to build scalability into their network automation designs. Gemini 3 modular RTU provides options for monitoring and control of several types of switchgear, using specific switch control modules. General purpose modules are available providing digital and analogue inputs and relay outputs, which can be used as additional I / O to a multi-switch control RTU or in a monitoring-only RTU. The Gemini 3 can control up to 14 switches.

- Ruggedised modules
- Designed for in-field handling
- Controls up to 14 switches
- Factory and field customisable
- Expandable with variety of modules
- Switchgear options without re-wiring
- Greater customisation, bespoke solutions
- Comprehensive power supply and UPS

Gemini 3 Mini RTU



The Gemini 3 Mini is the latest addition to Lucy Electric's Gemini family of RTUs. The Gemini 3 Mini range comprises small composite DIN rail sub-assemblies providing the optimum suitability for overhead and ground mount switchgear. It is designed to monitor and control switchgear used in medium voltage secondary distribution applications. Switch control is achieved locally with the HMI (common to the Gemini 3 Modular RTU) or remotely over a communication link.

The Gemini 3 Mini can control up to three switches with ordering option of 1 to 3 switches. The 1 switch option will control a single switch or circuit breaker while all of them can be used for RMU applications. Gemini 3 Mini RTU is also available without switch control for 'monitoring only' applications.

- Smaller footprint/ compact
- Designed for panel integration
- Controls up to 3 switches
- I/O expansion and analogue inputs via CAN bus expansion port
- Factory customised solution
- External power supply options

Housing Options

Gemini 3 RTUs are supplied ready to use in an enclosure (IP54 or 66) with batteries and connectors designed for switchgear mounting, pole mounting or freestanding. The Gemini 3 Modular is also available in component form for Lucy Electric partners allowing localised panel assembly. The Gemini 3 Mini is available as an open OEM solution for customers and localised panel and switchgear assembly. Both Gemini 3 Modular and Mini options are available integrated with Lucy Electric Aegis Plus and Aegis 36 ring main units, and Rapier overhead load break switches.

Gemini 3

Modular RTU

The Gemini 3 is a flexible Remote Terminal Unit (RTU) platform for advanced feeder automation on electrical distribution networks. It incorporates a range of features allowing customers to build in flexibility and scalability to their network automation.

The Gemini 3 modular design provides a secure operation with built-in diagnostics, continuous status monitoring and indication. The individual modules are rugged, making the device field serviceable, ensuring future proofing of the installation. The modules currently available in Gemini 3 are:

Master Control Module (MCM) – Contains the main processor and supervises all modules. The MCM handles the protocol communications.

Dual Switch Module (DSM) – Provides the inputs and outputs to perform secure interlocked control of two MV ring switches. Additional features available in DSM Plus module.

Power Supply Module (PSM) – Works with the switch control modules to provide secure switching operations. The PSM generates regulated power to all other modules and external communication equipment. The PSM also provides the intelligent battery charging function to maintain a secure supply.

Input Output Module (IOM) – General purpose module that covers digital and analogue inputs and relay outputs. It can be used as additional I/O to a multi-switch control RTU or in a monitoring only RTU.

Fault Passage Module (FPM) – Dual fault passage indicator module which detects and alarms for overcurrent and earth faults. This module also provides 3 phase current measurement for two circuits.

Human to Machine Interface (HMI) – Optional module that allows local control and monitoring without the need for a computer. It allows local controls to be issued by an authorised Engineer (security enabled) or just provide data to be viewed locally.



General features:

- 32-bit low power consumption microprocessor
- Built-in diagnostics, including temperature monitoring and hardware watchdog.
- Security enabled (firewall, SSL)
- Real time clock
- Communication ports
 - Dual isolated Ethernet ports, For TCP/ IP and VPN connections
 - Dual isolated RS232 ports, for serial transmission
 - Isolated RS485 port, for serial data transmission
- Communication protocols
 - DNP 3.0 TCP/IP or serial
 - IEC 60870-5-101
 - IEC 60870-5-104
 - Modbus TCP or RTU
- Programmability
 - Control logic function blocks
 - Dynamic dead-band to avoid unnecessary alarms configured in SCADA
- Supervisory selection and indication (off/ local/ remote)
- Event recording
 - 7000 events
 - 1ms resolution
- LED status indicators

Gemini 3

Mini RTU



The Gemini 3 Mini range comprises small composite DIN rail modules providing the optimum suitability for overhead and ground mounted switchgear. It is designed to monitor and control switchgear used in medium voltage secondary distribution applications. Switch control is achieved locally with the HMI module (common to the Gemini 3 Modular family) or remotely over a communication link.

The Gemini 3 Mini can control up to six switches with ordering options of 1 to 6 switches. The 1 switch option will control a single switch or circuit breaker while all of them can be used for RMU applications. Gemini 3 Mini is also available without switch control for 'monitoring only' applications. Additional options include comprehensive measurements, fault detection and automatic control functions.

Overhead applications

The Gemini 3 Mini single switch is designed for remote control of overhead load break switch units and is available in two variants: standard and advanced. The standard provides basic remote control capability, whereas the advanced additional measurements, including A, B, C, and R, S, T provides voltages on both sides of the switch, for fault detection and automatic sectionalising.

Ground-mounted applications

The Gemini 3 Mini is designed for remote control of up to six switches. The base control is for 1 to 3 switches with an option to control up to 6 switches. This supports different switchgear configurations and also provides additional functions including automatic change-over.

Gemini SCADA solutions

Lucy Electric offers entire electrical network remote control options via the use of Gemini automation and monitoring products. The technology is at the cutting edge of MV / HV switchgear design and innovation in the fields of both ground and pole-mounted switchgear. With these combined capabilities, Lucy Electric can offer its customers a truly systems-engineered approach to their turnkey MV electrical distribution requirements for the utility, industrial, commercial and infrastructure sectors.

Gemini SCADA provides a dynamic and robust medium for MV networks. It allows the user to have full visual control and information accessibility to any networked system architecture. The software has been developed as “application specific” for the control and monitoring of MV networks.

Characteristics

- Multiple communications to RTUs, IEDs, PLCs or other I / O devices
- DNP3, IEC 60870-5-101 / 104 – others on request
- Full OPC server and client support
- Serial or ethernet communication channels e.g. radio, GSM or GPRS

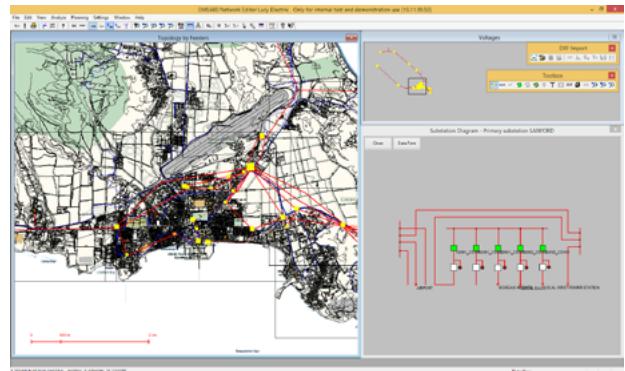

Capabilities

- Real-time data collection, database management and real-time dynamic data display
- Historical collection with real-time and historical trending graphs
- Alarm, event, sequence of event management
- Secure operator supervisory control
- User-based security
- On-line configuration

Safety Features

- Select before operate control
- Control time outs; control fail alarm
- Simultaneous control lock-out
- Control tagging (control lock-out)
- Information tagging

GridKey

Continuous substation monitoring

GridKey has been producing electrical monitoring systems since 2012. Designed to fit directly onto the distribution network, the GridKey system provides a cost effective, near real-time monitoring solution for the LV and MV Networks. By utilizing GridKey Electrical Utilities/Distribution Network Operators (DNOs) experience reduced network maintenance costs and significantly increased knowledge of the state of their LV/MV grid.

To maximise the value of the information captured from the monitoring system data is stored in a NoSQL database. A powerful analytics engine has been included in the Data Centre, carefully integrated with the NoSQL data storage. The package is completed by a Graphical Interface (GUI) which displays information in an intuitive way which facilitates decision-making and allows users to quickly see business and other critical information.

GridKey

MCU 318



GridKey is a custom designed continuous monitoring solution for low voltage (LV) networks. The MCU measures three phase only, on up to 6 ways and then synthesises the neutral current.

Quick and safe to connect, it can be retrofitted without the need for interruption and does not need an earth connection.

The system is weather-resistant meeting IP54 using a series of foam gaskets.

Primary communications are through its very sensitive GPRS modem making the MCU318 perfect for applications that face GSM network challenges, although options will allow both ethernet and RS485 communications as well.

Regular data reports are available and when used with the SlimSensor current sensor provide Class 2 accuracy between 4-720A. At any point in operation, this data reporting and alert messaging settings (for each MCU) can be individually re-configured remotely via its network interface. The operator can select the MCU measurement reporting interval from 1 minute, 10 minute or 30 minute periods, as needed.

Benefits

- Easy to fit and compact - custom designed for monitoring LV substations
- Robust and durable
- No calibration or maintenance
- Class 2 metering accuracy
- Weather resistant to IP54
- Comprehensive reporting of substation feeders
- 2 year, extendable, warranty
- 2.5G, GSM/GPRS mobile data transfer between unit and datacentre

Metrology

Measurement Standards	Class 2 in accordance with EN 62053-21 when used with Slimsensor current sensors
Electrical safety standards	EN 61010-1: 2010, with corrigendum May 2011 EN 61010-2-030: 2010
Over voltage	300 V rms Category IV, pollution degree 3
Current measurement range	Accurate up to 720 A AC per feeder phase No damage at any over-current condition
Operating voltage and measurement range	230V AC + 15%, -20% rms phase to neutral range
Line frequency	50Hz (nominal)

Protection, Environmental & Compatibility

IP Rating	IP54
Electromagnetic compatibility	EN 61000-6-2 immunity EN 61000-6-4 Emissions
Surge protection	IEC61000 6kV
Operating temperature range	- 20°C to 55°C (<93% RH, non-condensing)
Storage temperature range	- 25°C to 70°C
Altitude	Up to 2000m

Mechanical

Size (h x w x d)	300mm x 245mm x 80mm
Weight	1.35 kg
IP category	IP54 IEC 60529
Impact	EN 62262 IK06
Power	Power from single phase only, 6W typical, 11W maximum (GPRS enabled)
Communications interfaces	GSM/GPRS quad band 850/900/1800/1900 MHz Any network SIM can be provided by customer

GridKey

MCU 520

Medium Voltage (MV) monitoring

The MCU 520 MV measures the currents of the three phase and neutral, on up to 5 11kV (or 33kV) circuits.

The robust construction allows the unit to be IP65 rated, weatherproof for both indoor and outdoor use and through the use of various safety measures, it does - not require an earth connection.

Primary communication is via a built-in GPRS modem, although alternative external modems can be connected via an additional module.

In this configuration, the unit is powered from a standard 230v supply typically present in the Primary Substation for lighting, heating etc. – it has a nominal power requirement of 11W.

The voltage taps are made typically via connection to the protection VT outputs – these are just used for metrology so feed into high impedance inputs on the MCU 520 MV.

Current sensing is by a split core interposing CT which is fitted to the protection CT cables.

The system can provide both regular reports which can be remotely selected at rates from 1 minute to 24 hours. In addition the unit calculates and stores high resolution 1 second data reports and these can be transmitted on request as well as being able to provide a series of programmable alarms for over/under voltage and current.

Additional modules also provide the ability to connect a variety of additional sensors such as temperature, intruder or flooding and a modification can be provided to allow a “last gasp” communication in the event of complete power loss.



Metrology

Measurement standards	EN 62053-21 Class 1 for active energy EN 62053-23 Class 2 for reactive energy EN 60044-8 Class 1 for rms current
Electrical safety standards	EN 61010-1: 2010, EN 61010-2-030: 2010
Over voltage	300 V rms Category IV, pollution degree 3
Current measurement range	Accurate up to 720 A a.c. per feeder phase No damage at any over-current condition
Operating voltage and measurement range	230V AC + 15%, -20% rms phase to neutral range
Line frequency	50Hz (nominal)

Protection, Environmental & Compatibility

IP Rating	IP65
Electromagnetic compatibility	EN 61000-6-2 immunity EN 61000-6-4 emissions
Surge protection	EN 61000 6 kV
Operating temperature range	- 20°C to 55°C (<93% RH, non-condensing)
Storage temperature range	- 25°C to 70°C
Altitude	Up to 2000m
Last Gasp Power Supply	Optional module available

Mechanical

Size (h x w x d)	458 x 285 x 109 (with anti-tamper cover fitted)
Weight	3.25 kg
IP category	EN 60529 IP65
Impact	EN 62262 IK06
Power	Power from any phase 9 W typical, 15 W maximum (GPRS enabled)
Communications interfaces	GSM/GPRS quad band 850/900/1800/1900 MHz Any network (SIM can be provided by customer) LV TTL Serial – rates up to 1 Mbd Alternative Interface port (RS232, Modbus, Ethernet, DNP3, etc)*

*Future expansion via the Auxiliary port

Data Reporting/Storage

High resolution data	1 second data available on request from unit
Data reporting period	1 minute, 10 minute, 30 minute

GridKey

SlimSensor

With the Monitoring and Control Unit (MCU) the sensors form part of the innovative GridKey Low Voltage Substation Monitoring System. GridKey is revolutionising substation monitoring, providing continuous real time data on all feeder cables and is designed to connect LV monitoring to the Smart Grid.

Features and benefits:

- Quick and easy to fit – one-handed installation on tightly packed cables.
- Designed for retrofit and live fit.
- Low cost of installation and ownership – no calibration, no maintenance required.
- Most accurate flexible current sensor; not position sensitive, high cross coupling rejection.
- Robust, durable – designed for a minimum of 10 years continuous indoor or outdoor life (IP65).
- Monitor all feeder cables simultaneously: measurements enable management of a smarter grid.

Metrology	
Measurement Standards	IEC Standard 60044-8
Electrical safety standards	BS EN 61010-1: 2001, BS EN 61010-2-032: 2002
Sensor Type	Type B sensor as defined in BS EN 61010-2-032:2002, Category IV 300 V, pollution degree 3
Accuracy Class	Class 1 (calibrated), Class 2 (uncalibrated)
Rated current	600 A
Maximum current	2000 A
Output Strength	150 mV ac at rated current
Line Frequency	50 Hz
Protection, Environmental & Compatibility	
Surge protection	IEC61000 6 kV
Operating temperature range	- 20°C to 55°C (<93% RH, non-condensing)
Storage temperature range	- 25°C to 70°C
Altitude	Up to 2000 m
Mechanical	
Minimum required clearance between conductors	14 mm
Cable Length	2 m, 4 m, 6 m
Aperture	50 mm maximum conductor diameter
Weight	N/A
IP category	IP65 IEC 60529

GridKey

Data centre

There is a large quantity of data produced by the GridKey units, the Data Centre has been specifically designed to capture that data, analyse it and then display the actionable intelligence in an easy to understand format. The Data Centre has been designed to manage up to 10,000 GridKey systems simultaneously whilst

Data storage and management

To manage and safely store the volume of data collected we use a NoSQL database technology similar to that used by Amazon, Google and e-Bay. The design of the database balances data 'read and write' – ensuring that no data is lost when the units report and balancing this with the ability to read the data to allow the analytics to operate.

The GridKey Data Centre uses a variety of techniques to ensure this balance is maintained, including pre-processing to store the data in different forms as well as the raw data. It can manage in excess of 10,000 systems, reporting simultaneously without losing any data.

Analytics and alarms

A powerful analytics engine has been included in the Data Centre, carefully integrated with the NoSQL data storage. A series of analytics are in development – using both the data collected as well as monitoring the health of the GridKey units. Further packages are planned around the four themes of actionable information:

- **Faults** – diagnosing and fixing faults as efficiently as possible gets consumers back on power quickly, minimising labour and material costs for the distribution operator as well as minimising any fines or other payments levied for customer power interruptions. Work is being carried out by GridKey on certain types of fault to predict where and when these faults will occur allowing preventative maintenance to take place
- **Losses** – two types of losses are present: technical and theft. Technical losses are the result of assets, typically transformers and cables getting warm, and are caused by load and harmonic content. Balancing phase loads and minimising harmonic distortion reduce these losses. Theft detection is possible both

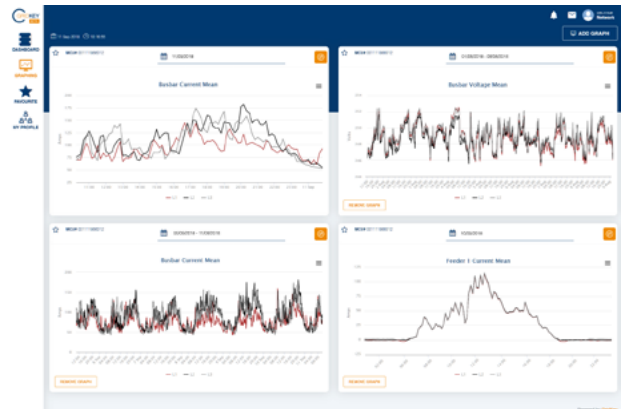

through the combination of domestic and commercial meter data with GridKey data and also through the detection of certain load profiles

- **Power quality** – meeting the quality standards for supply of electricity to consumers is a statutory requirement: monitoring provides details of voltage profiles including effects such as sag and swell as well as harmonic content
- **Planning** – maximising the life on the network, as well as planning replacement and reinforcement of the assets, is essential to managing capital funding spend. This is only possible by understanding the detailed load and voltage profiles of these assets and then analysing this to determine what actions are required

Graphic interface (GUI)

Displaying information in an intuitive way is essential. Learning from best practice in other sectors such as web design, the team have developed a highly visual user interface that presents data in clear, simple and easy-to-read screens. This facilitates decision-making and allows users to quickly see business and other critical information.

The GUI can be customised to business need and the user's role and personal preferences.

Key facts:

- It has a web-based interface so runs on any computer/tablet/ phone with a wide variety of browsers
- It displays information in a wider variety of ways – from a top down overview of all the monitoring systems reporting through to detailed analysis of the raw data of specific units.

Hosting

To improve resilience and protect against hardware failures we have created a four core system hosted on the cloud with a number of data protection features:

- A high integrity solution that ensures collected data is safe against a number of scenarios
- A data back up regime – both locally and off-site to allow full disaster recovery

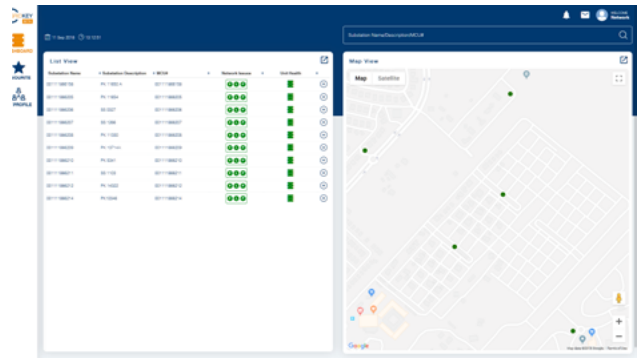

Security

Security of both the complete system and the data has been designed in from the start. We use a number of methods to ensure that the system cannot be compromised by unauthorised personnel either through the GridKey unit communications or through the web interface. The Amazon cloud solution is verified to ISO27000 and our cyber security measures have also been independently verified.

Data from individual customers is managed into separate accounts and can only be accessed by verified users. Varying levels of administration rights ensure that data access levels, by user, can be controlled within the Data Centre.

Integration with other systems

The GridKey Data Centre has been designed to integrate with other systems – both accepting and passing data and information to third party systems. The system integrates with a wide range of sources including internet and real devices with outputs managed through an OpenAPI interface. It also has an email server to allow alerts, alarms and reports to be sent directly to the user.



Lucy Electric
Technicians

Lucy
SABRE
VRN2A



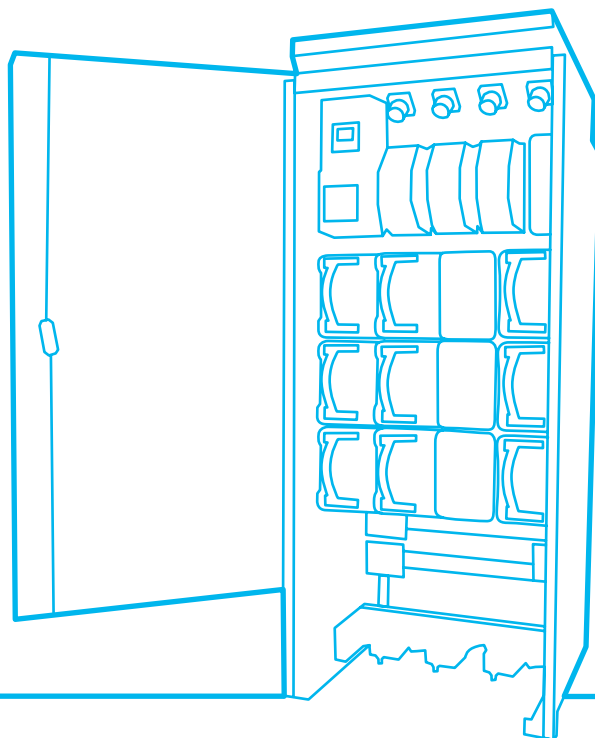

Low Voltage

Distribution cabinets

The comprehensive product portfolio includes wall, ground and transformer mounting cabinets suitable for a variety of different applications. The TMO cabinet features the enhanced safety AcuLok fuse handle.



Range table - Distribution cabinets

Distribution cabinets	Rated Voltage	Busbar rated current	Protection	Fuse type	Number of outgoing fuse ways	Mounting	Installation	Page
 <p>AcuLok Transformer mounted, outside</p>	400 V	1600 A	Fuse	BS88 J type 92mm	4 to 8	Transformer mounted	Outdoor	48
 <p>MSDB Vertical</p>	400 V	630 A	Fuse	BS88 J type 92mm	Up to 45	Wall/ground	Indoor	49
 <p>MSDB Horizontal steel</p>  <p>MSDB Insulated cabinets</p>	400 V	315 A 200 A (as appropriate)	Fuse	BS88 J type 82mm (when fitted)	From 7 to 16	Wall	Indoor	50
 <p>SMDB</p>	400 V	630 A	Fuse	BS88 J type 92mm	Up to 5	Wall	Indoor	51

AcuLok TMO

Transformer mounted distribution cabinet

The AcuLok fuse handle has deep skirt shrouding to protect the operator from any arc flash during fuse handle manipulation and clamps on to the fuse stalks in a single movement.



Characteristics

- Innovative, safe and operator friendly fuse handle technology
- Up to 8 outgoing fuse ways with 630 A rating
- Deep skirt shrouding around fuse handle for protecting operators against arc flash
- Independent load make – load break disconnecter switches for all three phases
- Insulated Rogowski coil tube per fuse handle
- Multi-functional digital meter with communication options
- Veam Power Lock standby generator sockets with earth for emergency supply
- IP34D protection for indoor and outdoor installation

Technical Data

Rated voltage	400 V
Rated current outgoing fuse ways	630 A
Rated current load break disconnecter	1000 / 2000 A
Mode of fault current interruption	Fuse
Number of outgoing fuse ways	4, 5, 6 or 8
Fuse types	BS88 J type, 92mm
Mounting options	Transformer mounted with 'F' type flange
Cable connection	3C / 4C, 300 mm ²

Multi service distribution boards (MSDB)

Vertical phase arrangement



Mild steel wall mounting distribution boards for 3 phase systems configurable with either a single incoming bank of triple pole J type slotted tag fuses or with an additional outgoing bank of triple pole J type fuses for mixed developments requiring a split supply greater than 100 A.

Characteristics

- Up to 45 outgoing 3 phase fuse ways
- 1 J and 2 J versions available in left or right hand layouts
- Top or bottom entry
- 2 door design with segregated access to DNO fuses
- Thumb screw operated fuse handles with 92 mm BS88 J type fuses
- BS7657 outgoing fused ways
- Polyester powder coated steel enclosure
- Suitable for 3C or 4C networks
- Pre-drilled removable gland plates

Technical Data

Busbar rated current	630 A
Rated voltage	400 V
Rated insulation voltage	690 V
Fuse way maximum rating	630 A
Max incoming cable size	4C, 300 mm ²
Cable connection	Via mechanical shear off connectors

Multi service distribution boards (MSDB)

Horizontal phase arrangement

The outgoing service way fuses are aligned horizontally in these smaller distribution boards. They are mostly configured for direct busbar connection although certain variants have provisions for a fused incomer as indicated in the table below.

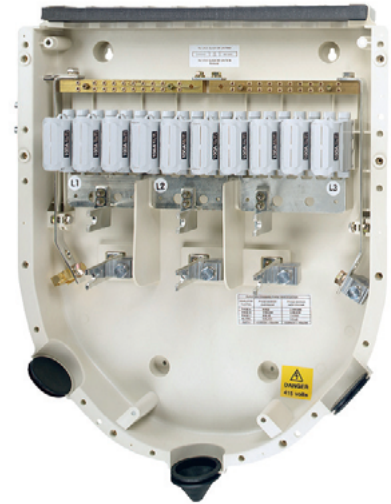

MSDB 10 way fused incomer

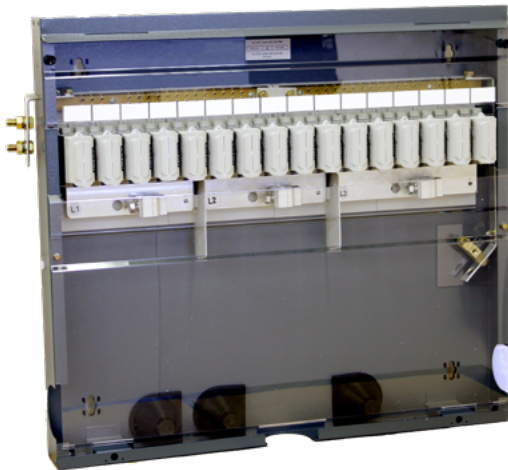

MSDB 16 way



MSDB 7 way

Configurations

Type	Cabinet material	Busbar rating	Maximum incoming cable
7 way compact	Steel	200 A	35mm ²
7 way standard	Steel	200 A	25-95mm ²
7 way standard (fused incomer)	Steel	200 A	35mm ²
10 way	Insulated	315 A	185mm ²
10 way (fused incomer)	Insulated	315 A	185mm ²
10 way	Steel	315 A	185mm ²
16 way	Steel	315 A	185mm ²

Sub mains distribution boards (SMDB)



Wall mounting cabinets which accept single incoming supply and provide up to 5 outgoing J type triple pole fuse ways for indoor applications only.

Characteristics

- Up to 5 outgoing 3 triple pole fuse ways
- Thumb screw operated fuse handles with 92 mm BS88 J type fuses
- IP2XB internal protection
- Configurable for direct connection to busbar
- Double door cabinets
- Suitable for 3C or 4C networks
- Polyester powder coated steel enclosure

Technical Data

Busbar rated current	630 A
Rated voltage	400 V
Rated insulation voltage	690 V
Fuse way maximum rating	630 A
Max incoming cable size	4C, 300 mm ²
Cable connection	Via mechanical shear off connectors



Low voltage

Cut outs

Providing a robust and durable solution for the vast majority of LV protection and distribution requirements up to 630 A, the cut out range has kept abreast of market demands in terms of performance and versatility.

With a service life expectancy often exceeding 20 years, these products can stand the test of time.

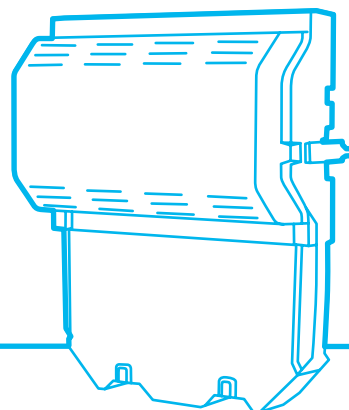

Range table - Cut outs

Cut Outs	Rated Voltage	Busbar rated current	Protection	Fuse type	Number of outgoing fuse ways	Mounting	Installation	Page
 Heavy duty	230 / 400 V	630 A	Fuse	BS88 J	Three phase	Wall	Indoor	55
 Integrated CT Metering and heavy duty cut out	400 V	630 A	Fuse	-	Three phase	Wall	Indoor	56
 Pole mounted	400 V	400 A	Fuse	BS88 J	Single	Pole	Outdoor	57
 ABC distribution box	230 / 400 V	200 A	-	-	Up to 9 outgoing unfused ways	Wall or pole	Outdoor	58
 Indoor house service	230 / 400 V	100 A	Fuse	BS1361	Single / three phase	Wall	Indoor	59
 Outdoor house service	230 / 400 V	100 A	Fuse	BS1361	Single / three phase	Wall	Outdoor	60

Heavy duty cut outs

Wall mounting fused service heads with ratings up to 630 A for indoor applications. Available also with an integral CT metering chamber which accepts latest generation smart meters.



Characteristics

- 200, 400 and 630 A versions
- Thumb screw operated fuse handles with 83 mm BS88 J type fuses for 200 A
- Thumb screw operated fuse handles with 92 mm BS88 J type fuses for 400 and 630 A versions
- Transparent internal shrouds over terminations provides IPXXB protection with handles in place
- Soft PVC shrouds for protection of incoming stalks with fuse handles removed
- Suitable for 3C CNE or 4C SNE installations
- Versions with no external earth connection
- Robust thermoplastic enclosure construction
- Sealable covers and cable troughs with interlocked covers
- Choice of shear off mechanical or lug incoming terminations
- Choice of leader clamp, mechanical shear off or lug outgoing terminations

Technical Data

Busbar rated current	200, 400 or 630 A
Rated voltage	400 V
Rated insulation voltage	690 V
Fuse handle maximum rating	As above
Max incoming cable size (630A)	300 mm ²
Max incoming cable size (200A)	185 mm ²
Cable connection	Via mechanical shear off connectors, lugs (optional leader clamps on outgoing)

Integrated CT metering & heavy duty cut outs

Wall mounting fused service heads with integrated CT metering having ratings up to 630 A for indoor applications. Accepts smart meters with standard ISO mountings.



Characteristics

- Single ratio metering class 0.5 CTs for all variants
- Pre-wired with loom for direct connection of meter
- VT protection fuses and solid neutral link
- Segregated compartment design giving access firstly to meter check terminals then service connections
- Transparent internal shrouds over terminations provides IPXXB protection with compartment door open
- Suitable for 3C CNE or 4C SNE installations
- Robust thermoplastic enclosure construction mounted on pre-drilled backboard
- Sealable covers
- Choice of shear off mechanical or lug incoming terminations
- Choice of leader clamp, mechanical shear off or lug outgoing terminations

Technical Data

Busbar rated current	200, 400 or 630 A
Rated voltage	400 V
Rated insulation voltage	690 V
Fuse handle maximum rating	As above
Max incoming cable size (630 A)	300 mm ²
Max incoming cable size (200 A)	185 mm ²
Cable connection	Via mechanical shear off connectors, lugs (optional leader clamps on outgoing)
CT ratios	200 / 5, 400 / 5 and 600 / 5
CT rated burden	5 VA
CT conformity	IEC 60044-1, 1357626 and IEC 185
Backboard fire retardant	Euro Class C

Pole mounted cut outs

Fused 400 A rated cut outs for pole mounting.



Characteristics

- Accepts up to 300 mm² aluminium and copper conductors
- High grade engineering thermoplastic for excellent UV resistance
- IP43 rating
- Thumb screw operated fuse handle with brass clamps
- Fixing via single coach screw
- Closed cell foam cable grommets

Technical Data

Continuously rated current	400 A
Rated voltage	400 V
Wedge clamp material	Brass
Fuse handle maximum rating	400 A
Max incoming cable size (630 A)	300 mm ²
IP rating	IP43
Cable connection	Via mechanical shear off connectors or compression lugs

ABC distribution boxes

200 A rated distribution boxes for pole or wall mounting.



Three phase

Characteristics

- Single phase ABC box supplies up to 3 service ways
- Three phase ABC box supplies up to 9 service ways
- CNE and SNE versions
- Accepts up to 120 mm² incoming ABC type conductors
- High grade engineering thermoplastic for excellent UV resistance
- IP44 rating
- Two M8 pinching screws per conductor
- Grease filled terminal blocks
- Hinged door with restraint
- Foam self-sealing cable entry gasket
- Optional metal frame for mounting to concrete poles

Technical Data

Continuously rated current	200 A
Rated voltage	400 V
Rated insulation voltage	690 V
Number of outgoing service ways	3 or 9
Max incoming cable size	120 mm ²
IP rating	IP44
Cable connection (per conductor)	2x pinching screws in tunnel terminals



Single phase

Indoor house service cut outs

Fused cut outs in either CNE or SNE formats conforming to BS7657:2010 for the supply of domestic or light commercial installations.



Characteristics

- Dual phase and neutral terminals accept up to 35 mm² conductors
- Three phase CNE / SNE combinations with cable chambers
- 22 mm or 30 mm fuse barrel size depending on amperage
- Reversible mounting (phase on left or right hand side) for all variants
- Special version for legacy installations with PILC cables
- Fire resistant slope board for mounting in meter cupboards
- Two brass M8 pinching screws per conductor
- Interlocked shrouds and covers with sealable fuse handle
- Silver plated phase terminal block

Technical Data

Current ratings	60 / 80 and 100 A
Rated voltage	230 / 400 V
Fuse type	BS1361 Type IIa and IIb
Supply frequency	50 Hz
Max incoming cable size	35 mm ²
Recommended terminal torque	3.25 Nm
Cable connection per conductor	2 x M8 screws in tunnel terminals

Outdoor house service cut outs

Wall mounted insulated enclosures equipped with one single phase or one three phase 100 A house service cut out. Featuring sealable covers for enhanced tamper resistance, the outdoor service units are IP55 rated and are engineered for under eaves installation.





Characteristics

- Tough, weatherproof enclosure
- Removable backplate sub assembly
- External fixing feet for wall mounting
- Versatile glanding arrangements
- Flame retardant material with excellent UV resistance

Technical Data

Current rating	100 A
Rated voltage	230 / 400 V
Fuse type	BS1361 Type IIa and IIb
IP rating	IP55
Recommended terminal torque	3.25 Nm

Range table - Low voltage air insulated switchgear

Air Insulated switchgear	Rated Voltage	Mode of fault current	Insulation medium	Rated current	Mounting	Installation condition	Operation	Cable access	Page
 SMART CDC	690V	Vaccum	Air	5000	Ground	Indoor	Local/ remote	Rear/ top	62
 SMART CCM	690V	Vaccum	Air	3200	Ground	Indoor	Local/ remote	Rear/ top	63

SMART CDC

LV load distribution centre

SMART CDC features the best of low voltage electrical panel technology, and allows for easy assembly, installation, maintenance and panel operation.

Due to its standard and modular design, it's easy to plan a SMART CDC panel that will fit in the available space in the room.



Characteristics

The following attributes are available for all SMART CDC panels:

- Cable in (one circuit breaker per panel)
- Interconnection
- Busbar connection
- Cable out (one or two circuit breakers per panel)
- Tested for the seven criteria of the internal arc in low voltage panels standard (IEC-TR 61641)

Electrical characteristics

Technical Data		
Maximum rated voltage	V	690
Rated operation voltage	V	480/440
Rated insulation voltage	V	600
Rated lightning impulse withstand voltage	kV	8.0
Maximum rated current	A	Up to 5000
Rated short-time withstand current	kA	65
Withstand current peak	kA	143 (In factor 2.2)
Duration of withstand current	s	1
Rated frequency	Hz	50/60
Rated diversity factor	PU	1
Internal arc withstand current	kA	50
Duration of arc withstand current	s	0.3
Altitude	m	2000
Overvoltage category		IV

Mechanical characteristics

Technical Data	
Cable in&out options	Top or bottom
Maximum number of circuit breakers per panel	1 (cable in and interconnection) 2 (cable out)
Maximum operation altitude	2000
Type of installation	IP42 - Indoor
Dividing and frame plates' thickness	14 MSG
Colour	Munsel 6.5

SMART CCM

LV motor control centre

The SMART CCM Low Voltage Motor Control Centers are modular units, developed in accordance with IEC 61439, ensuring the highest standards of requirements adopted worldwide.

The design encompasses the best of low voltage electrical panel technology, allowing for easy assembly, installation, maintenance and panel operation. It also fully complies with the 7 criteria of IEC-TR 61641, ensuring confinement of the electrical arc in its drawers.



Electrical characteristics

Technical Data		
Maximum rated voltage	V	690
Rated operation voltage	V	480 / 440
Rated insulation voltage	V	600
Rated lightning impulse withstand voltage	kV	8.0
Maximum rated current	A	Up to 3200
Rated short-time withstand current	kA	65
Withstand current peak	kA	143 kA (In factor 2.2)
Duration of withstand current	s	1
Rated frequency	Hz	50 / 60
Rated diversity factor	PU	1
Internal arc withstand current	kA	50
Duration of arc withstand current	s	0.3
Altitude	m	2000
Overvoltage category		IV

Mechanical characteristics

Technical Data	
Cable in & out options	Top or bottom
Maximum number of fixed or withdrawable drawers per panel	11
Drawer extraction type	Manual, with lever
Maximum operation altitude	2000 m
Type of installation	IP42 - Indoor
Dividing and frame plates' thickness	14 MSG
Colour	Munsel 6.5

Energy Services

Complete product lifecycle solutions

Our aim at Lucy Electric is to ensure that you consistently get the very best from our technology – and your budgets. With our integrated set of product lifecycle services, ranging from after sales support to training and consultancy, we provide incisive expertise and timely assistance throughout the lifecycle of your high performance Lucy Electric products.

Whether you are managing extensive distribution networks, expanding, updating or automating your operation, Lucy Electric has the products and services to give you peace of mind that your assets are being effectively managed and maintained.

Complete product lifecycle solutions

1. Installation

- A. Offloading and site erection
- B. Full turnkey projects

2. Commissioning

- A. Pre-commissioning services
- B. Final commissioning and energisations
- C. Specialist commissioning services (G59 testing or similar)

3. Maintenance and support

- A. Non-intrusive (thermal, partial discharge and other services)
- B. Intrusive
- C. Full maintenance contracts which also include options such as extended warranties
- D. Supply a range of spares

4. Consultancy

- A. Consultancy for extension, upgrades and retrofitting of switchgear to maximise asset performance and avoid unexpected failures and production losses

5. Training

- A. Product familiarisation courses
- B. Full knowledge transfer programmes
- C. Bespoke courses

6. Emergency response

- A. Emergency response services for contracted customers
- B. 24/7 support line

7. Modifications

- A. Upgrades to installed assets which could include automating an RMU for example

8. De-commissioning

- A. Full end of life services including de-commissioning and disposal of assets
- B. Asset replacement services

9. Technical support

- A. Pre-installation design and support services
- B. Post installation support services, for a range of scenarios
- C. Technical support for our complete range of products

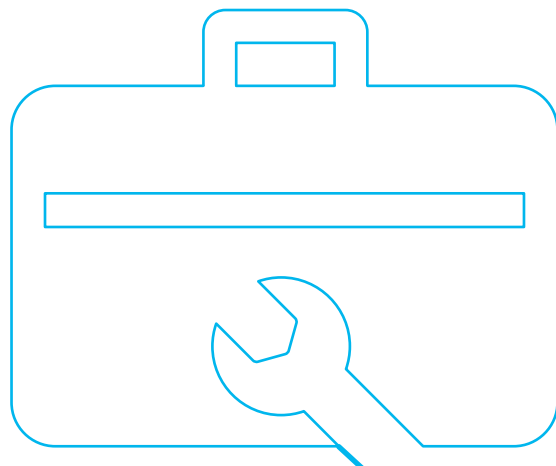

Disclaimer

Lucy Electric has a policy of continuous research and development and accordingly reserves the right to change the design and specification of its products without prior notice.

Lucy Electric worldwide offices

Lucy Electric Ltd.

Howland Road, Thame, Oxfordshire,
OX9 3UJ, United Kingdom
Tel: +44 1844 267 267 General
Tel: +44 1844 267 222 Sales
Fax: +44 1844 267 223
Email: salesuk@lucyelectric.com

Lucy Middle East FZE.

PO Box 17335, Jebel Ali, Dubai,
United Arab Emirates
Tel: +97 148 129 999
Fax: +97 148 129 900
Email: salesme@lucyelectric.com

Lucy Electric (Thailand) Ltd.

388 Exchange Tower, 37th Flr Unit 3702,
Sukhumvit Road, Klongtoey Sub district,
Klongtoey District, Bangkok,
10110, Thailand
Tel: +66 (02) 663 4290
Fax: +66 (02) 663 4293
Email: salesth@lucyelectric.com

Lucy Switchgear Arabia Co. Ltd.

Novotel Business Centre,
P.O. Box 35340, Dammam 31488,
Saudi Arabia
Tel: +966 138 147 910
Fax: +966 138 147 914
Email: salessa@lucyelectric.com

Lucy Electric (South Africa).

Unit 12 & 13, Block C,
Honeydew Business Park,
1503 Citrus Street, Laser Park,
Honeydew, 2170, South Africa
Tel: +27 11 025 7490
Fax: +27 11 794 3277
Email: salesza@lucyelectric.com

Postal Address:

P.O. Box 1078, Honeydew, 2040

Lucy Asia Pacific Sdn Bhd.

L17-05-06, PJX-HM Shah Tower,
No16A Jalan Persiaran Barat,
46050 Petaling Jaya, Selangor, Malaysia
Tel: +603 74910700
Fax: +603 79316923
Email: salesmy@lucyelectric.com
Email: saleschina@lucyelectric.com

Lucy Electric India Private Ltd

F-10, MIDC, Ambad
Nasik 422010
India
Tel: +91 253 2381603
Fax: +91 253 2381247
Email: leindia@lucyelectric.com

Lucy Equipamentos Elétricos Ltda.

Av. das Araucárias 2558
Thomaz Coelho, CEP 83707-067,
Araucária Paraná State, Brazil
Tel: +55 (41) 2106 2801
Email: salesbrazil@lucyelectric.com

engineering intelligent solutions
www.lucyelectric.com